

## MDVH Family

### MDVH500 Series

## High voltage input DC/DC converters



### Description

**Compact isolated DC/DC converters of MDVH Series** for industrial and special purpose applications. Despite the small size (110×84,2×12,85 mm) the maximum output power of modules reach up 500 W and they are able to operate in a wide case operating temperature range (–60...+125°C). These modules have functions of remote on/off, remote feedback, short circuit, overcurrent and thermal protection and can operate in parallel mode. Without optocouplers in the converter's circuit it can safely operate in conditions of ionizing radiation and high temperature. Units have variable protections from different factors: vibration, dirt, moisture fog and salt fog.

These modules undergo special thermal and limit test including burn-in test with extreme on/off modes.

### Compliance

- MIL-STD-810G
- MIL-STD-461F (CE102)
- MIL-STD-704F



Description of MDVH Family on the manufacturer's website  
[eng.aedon.ru/pr-hv.php](http://eng.aedon.ru/pr-hv.php)

### Features

- 5 year warranty
- Output current up to 30 A
- 270 VDC (index "M") input compliant with MIL-STD-704F
- Low-profile design (12,85 mm) with cylindrical pin outs
- Case operating temperature –60...+125°C
- 125 °C baseplate operation without derating
- Magnetic feedback without optocouplers
- Short circuit protection, overvoltage, thermal protection
- Remote on/off
- Output voltage adjustment
- Typical efficiency 89% (Uout.=24 VDC)
- Parallel operation, remote feedback
- Parallel or series mode
- Polymer potting sealing

### Order registration

+7 473 200 87 80, Global Operations Team

### Technical support

[techsup@aedon.ru](mailto:techsup@aedon.ru)

### Reliability test

[eng.aedon.ru/downloads/documentation/Reliability-Test\\_ENG.pdf](http://eng.aedon.ru/downloads/documentation/Reliability-Test_ENG.pdf)

## Ordering information

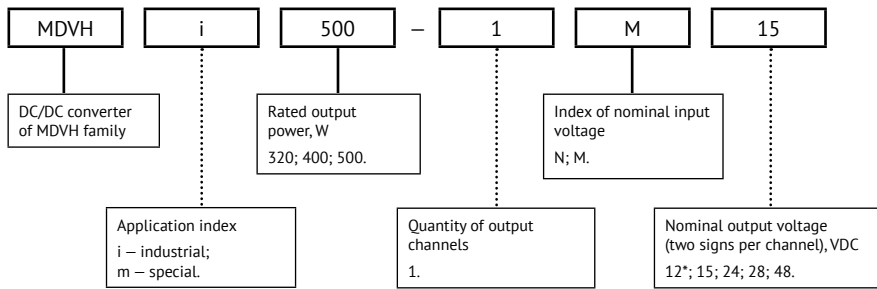

For more information please contact our Global Operations Team

+7 473 200 87 80  
[info@npo-enel.ru](mailto:info@npo-enel.ru)

\*500 W model does not support the output voltage of 12 VDC.

## Application index

Parameter	Index "m"	Index "i"
Case operating temperature	-60...+125°C	-40...+85°C
Compliance	MIL-STD-810G	-
	EN60950-1	+
	MIL-STD-461F	CE102
	MIL-STD-704F	270 VDC input (index "M")
Total regulation (Inom 10–100%)	±6%	±4%
Vibration proof	+	-
Moisture proof (Tamb.=25°C)	98%	60%
Dust proof	+	-
Salt fog resistant	+	-
Typical MTBF	2 000 000 hrs	500 000 hrs
Failure rate	<0,05%	<1%
Warranty	5 years	3 year

## Rated output power and current

Power	320 W					400 W				500 W		
	5	12	15	24	28	12	15	24	28	15	24	28
Output voltage, VDC	5	12	15	24	28	12	15	24	28	15	24	28
Rated output current, A	30	26,6	21,3	13,3	11,2	30	26,7	16,7	14,2	30	20,8	17,8

Other output voltage within range 3...70 VDC is also available upon special request.

## Index of nominal input voltage\*

Parameter	Index "N"	Index "M"
Nominal input voltage, VDC	110	270
Input voltage range, VDC	82...154	175...350
Transient deviation (1 s), VDC	52...170	175...400
Typical efficiency for Uout.=24 VDC	85	89

\* Reflected input ripple current (10–10000 Hz) – 8% Uin. nom

## Specifications

All specifications valid for normal climatic conditions (ambient temp. 15...35°C; relative humidity 45...80%; air pressure 8,6\*10<sup>4</sup>...10,6\*10<sup>4</sup> Pa), U<sub>in</sub>. nom, I<sub>out</sub>. nom, unless otherwise stated. It is important to note that the information herein is not full. More detailed information (specific requirements, basic connection circuits, operating instructions etc.) can be found on our web-site: [eng.aedon.ru](http://eng.aedon.ru)

### Output specifications

Parameter		Value
Output voltage adjustment		5% U <sub>out</sub> . nom
Total regulation	Input voltage variation (U <sub>min</sub> ...U <sub>max</sub> )	max ±2%
	Load variation (10...100% I <sub>max</sub> )	
Ripple and noise (p-p)		<2% U <sub>out</sub> . nom
Maximum capacitive load	12 VDC	1000 µF
	24 VDC	150 µF
	48 VDC	70 µF
Start up time (remote)		max 0,1 s
Overload protection level*	320 W	<2,8 P <sub>max</sub>
	400 W	<2,2 P <sub>max</sub>
	500 W	<1,8 P <sub>max</sub>
Short circuit protection*		hiccup auto recovery
Overvoltage protection		1,5 U <sub>nom</sub>

\* Parameters are stated for the information purposes and could not be used at long term work, exciding maximum output current, at work outside of a range of operating temperatures.

### General specifications

Parameter		Value
Case temperature	Operating (natural convection) – power derating (natural convection) – without power derating with heatsink	–60...+125°C see power derating diagram (dashed, dash-dotted curve) see power derating diagram (solid curve)
	Storage	–60...+125°C
Switching frequency		130–150 kHz
Isolation capacitance	input/output	1500 pF
Isolation voltage (60 s)	input/output	1500 VDC
	input/case	500 VDC
	output/case	500 VDC
Isolation resistance @ 1500 VAC	input/output	20 MOhm min
Thermal impedance		3°C/W
Thermal protection level		118...125°C, clamp, auto recovery
Remote on/off		Off.: connection of pins "ON" and "–IN", I <sub>s</sub> ≤ 5 mA

## Specifications (cont.)

### Physical specifications

Parameter	Value
Case material	aluminium
Potting	epoxy polimer
Pin material	phosphor bronze, SnP8 plated
Weight	max 250 g
Soldering temperature	260°C @ 5 s

### Design topology

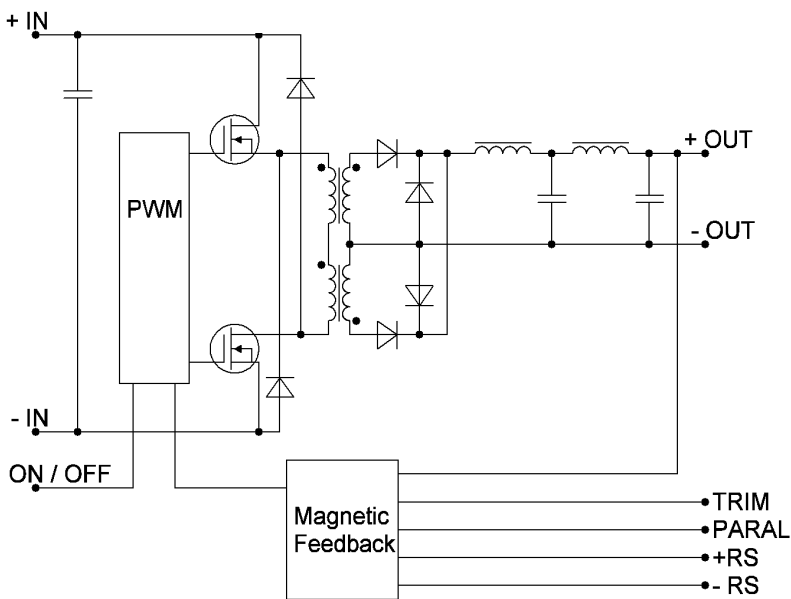

Figure 1. Design topology.

## Service functions

### Typical connection

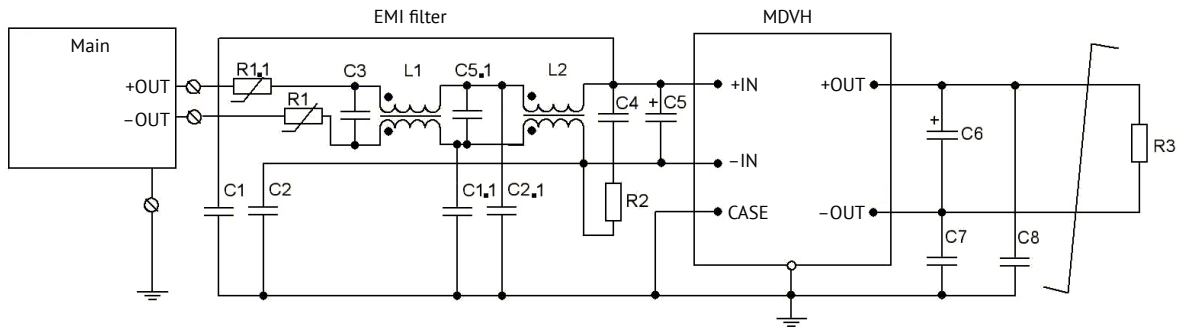

Figure 2. Design topology with filtration unit.

R2	resistor			1 Ohm
R1, R1.1	NTC-thermistor			2 Ohm
C1, C2	ceramic capacitor			4700 pF 500 VDC min
C1.1, C2.1	tantalum capacitor			0...2200 pF
C7, C8	tantalum capacitor			2200...4700 pF
C4 C5	electrolytic capacitor capacitor type CL21 std GB7335	Input voltage	110 VDC 270 VDC	47-82 uF 450 V 150 uF 450 V
C6	tantalum capacitor	Output voltage	12 VDC 24 VDC 48 VDC	250 uF 38 uF 18 uF
L1	common mode choke			2 mH
L2	common mode choke			20 mH
C3 C5.1	capacitor type CL21 std GB7335 electrolytic capacitor	Input voltage	110 VDC 270 VDC	470...1000 uF 450 V 22...47 uF 450 V

## Service functions (cont.)

### Remote control

Function of remote control by a signal allows to control the unit's operation using mechanical relay or electric switch of "open collector" type.

The unit should be powered off by connecting "ON" output to "-IN" output. The switch can carry current of up to 5 mA, the max voltage drop on the switch should be less than 1,1 V.

The unit is powered on by disconnecting the switch within the time less then 5  $\mu$ s. Being disconnected the switch is applied by approximately 5 V, allowable current leakage through the switch should not be over 50  $\mu$ A.

To arrange remote power off/on of several units simultaneously it is not allowed to use additional elements in the circuit to connect outputs "ON" and "-IN" and a switch.

If the function of remote power off/on is not used, "ON" output is allowed to be left unconnected.

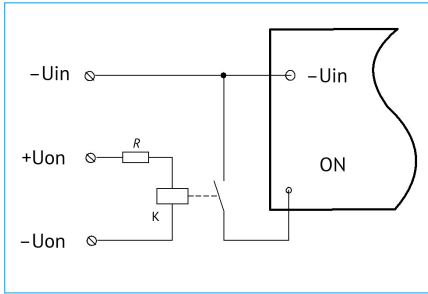

Figure 3 (a). Layout of mechanical relay control.

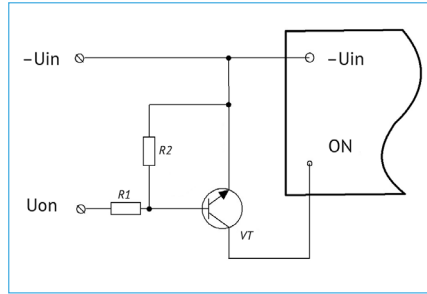

Figure 3 (b). Layout of bipolar transistor control.

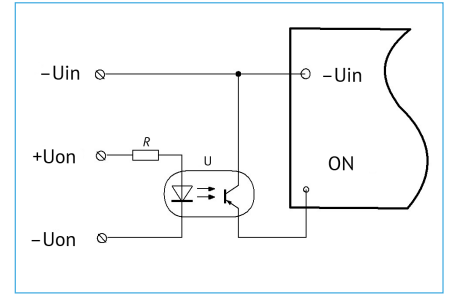

Figure 3 (c). Layout of optocoupler control.

### Adjustment

Adjustment of output voltage of a power supply unit within the range of at least  $\pm 5\%$  can be done by connecting "TRIM" output (if available) through "-OUT" output to increase output voltage, or through "+OUT" output to decrease the output voltage.

In case of using variable resistor Rvar and outside resistors (R1, R2) it is possible to fulfill the adjustment both to increase and decrease the output voltage.

If you need to control the output voltage of a power supply unit by a signal from external source of current or voltage, e.g. in micro-controller automated control systems using DAC, the external current or voltage signal should be supplied to the adjustment output relating to "-OUT" output, as shown in the drawings (b) and (c).

Calculation formula of nominal values of circuit elements (a), current (b) and voltage (c) can be found in Technical Guides available on [www.eng.aedon.ru](http://www.eng.aedon.ru).

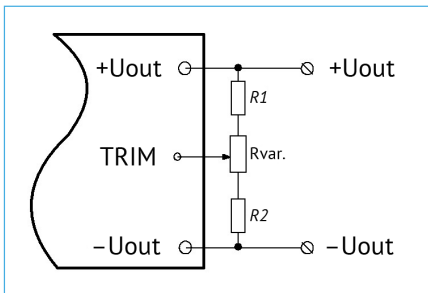

Figure 4 (a).

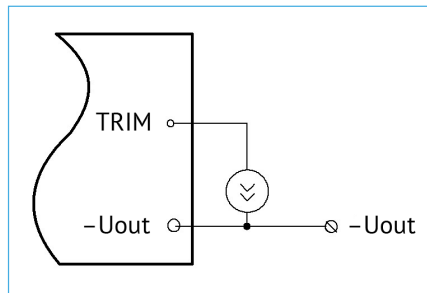

Figure 4 (b).

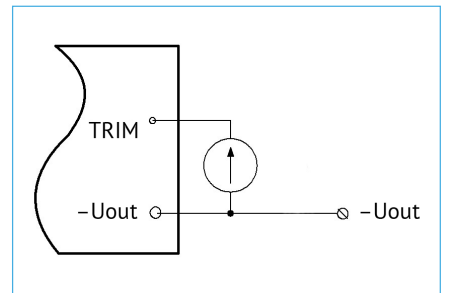

Figure 4 (c).

## Efficiency

### VS load

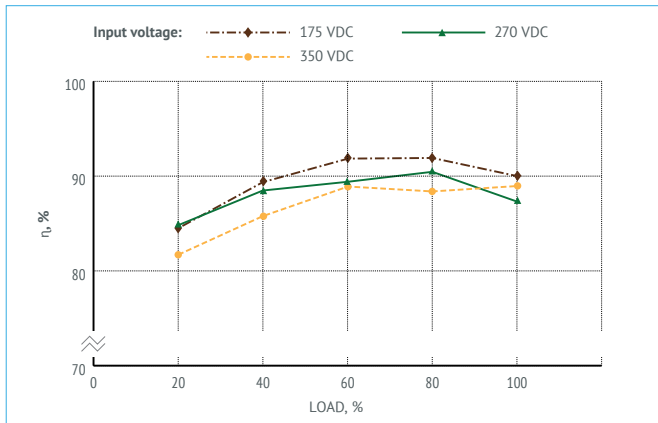

Figure 5. Efficiency of MDVHx400-1M28.

## Power derating

### VS ambient temperature and baseplate temperature

The PSU is able to operate with 100% load within the complete range of case operating temperature (−60...+125 °C). On condition the case temperature is kept from −60°C to 125 °C the PSU will operate without derating regardless of the ambient temperature. Thermal Management section of the Application Notes shows the resulting heatsink area, as well as baseplate-vs-ambient thermal resistance, the min thickness of the heatsink, and the max PSU output power without heatsink.

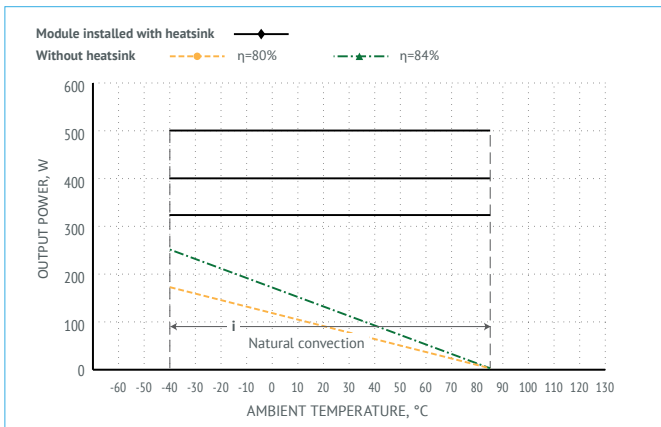

Figure 6 (a). Power derating of MDVHi500.

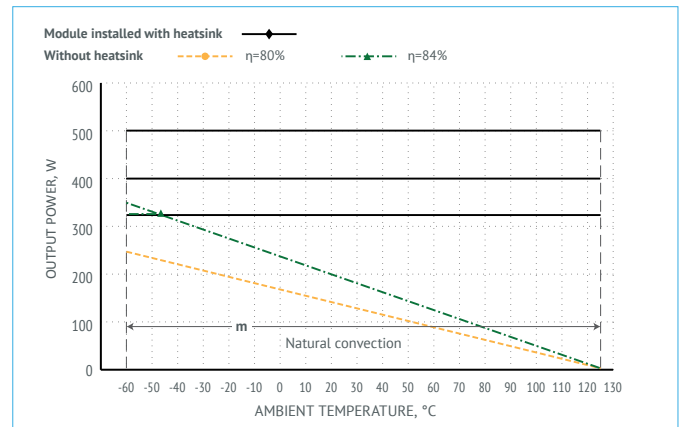
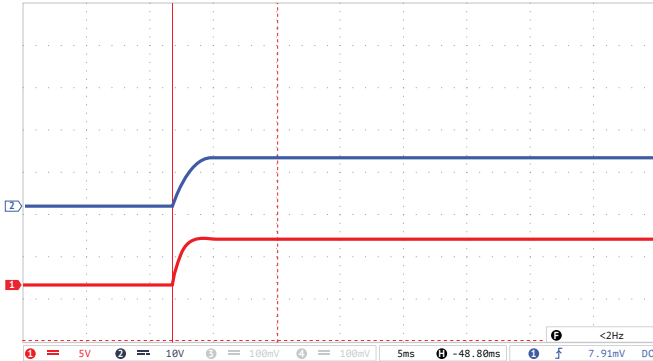

Figure 6 (b). Power derating of MDVHm500.

## Oscillograph charts of MDVHx500-xxx

Testing conditions  $U_{in}=270$  VDC,  $I_{out}=30$  A,  $T_{amb}=25^{\circ}\text{C}$ ,  $U_{out}=12$  VDC,  $C_{out}=100$   $\mu\text{F}$

The database of regulated parameters of the manufactured products is available. Pls. contact your personal manager or customer support service to get necessary information.

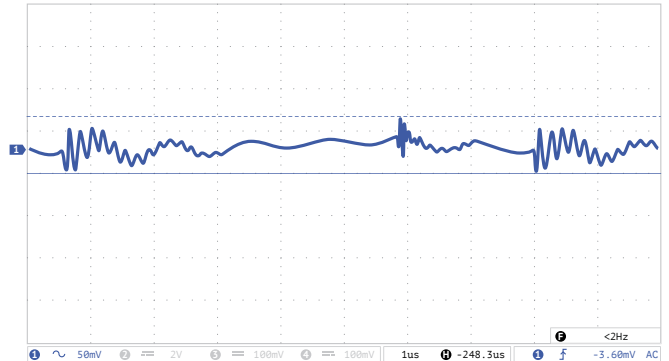

**Figure 7 (a).** Oscillograph chart of setting output voltage after supplying remote control signal to ON-output.

Ray 1 (red) – output voltage. Scale 5 V/div.

Ray 2 (blue) – voltage at ON-output. Scale 10 V/div.

Time scale  $t=5$  ms/div.

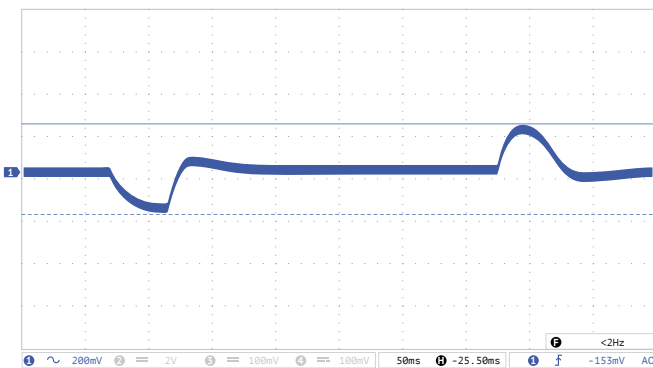

**Figure 7 (c).** Oscillograph chart of output voltage ripple.

Ray 1 (blue) – ripple of output voltage. Scale 50 mV/div.

Time scale 1 us/div.

Measuring technique: see Electrical Test Screen.



**Figure 7 (d).** Oscillograph chart of voltage transient deviation during load “drop/rise”.

Ray 1 (blue) – output voltage. Scale 200 mV/div.

Time scale  $t=50$  ms/div.

Modes:

- “drop” output current variation (10...100%)  $I_{nom}$ ;
- “rise” output current variation (10...100%)  $I_{nom}$ ;
- build-up time 500 us.



## Noise spectrogram

Testing according to MIL-STD-461F CE102. (Tcase=25°C, Vin.=+12 V, full load, unless otherwise specified)

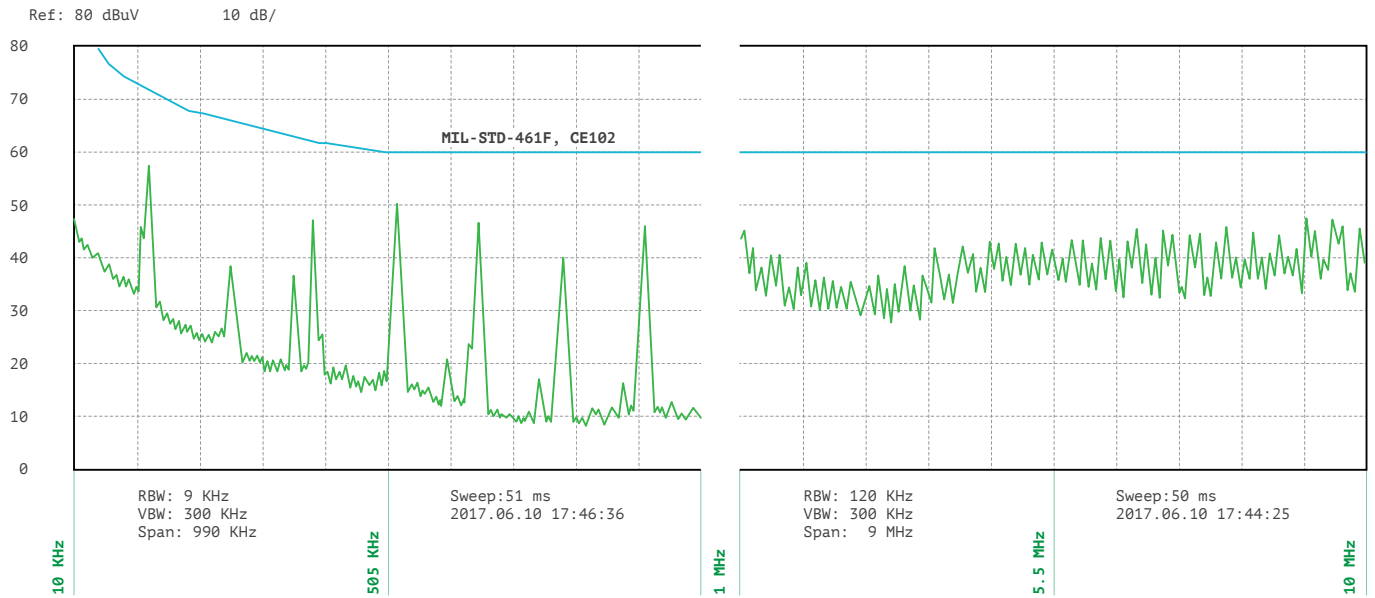

Figure 8. Spectrogram of MDVH500-1M28 with typical connection diagram.

## Outline dimensions

### Models packed in reinforced case with flanges

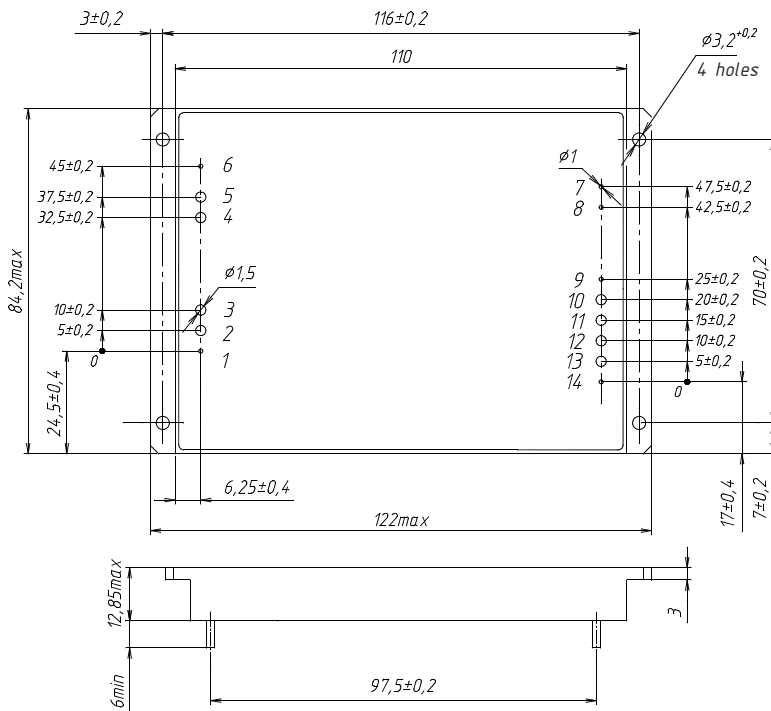

Figure 9. Single-output models.

### Pin out

Pin #	1	2, 3	4, 5	6	7	8	9	10, 11	12, 13	14
Function	ON	-IN	+IN	CASE	PARAL	TRIM	-RS	-OUT	+OUT	+RS

## Accessories

### Heatsink

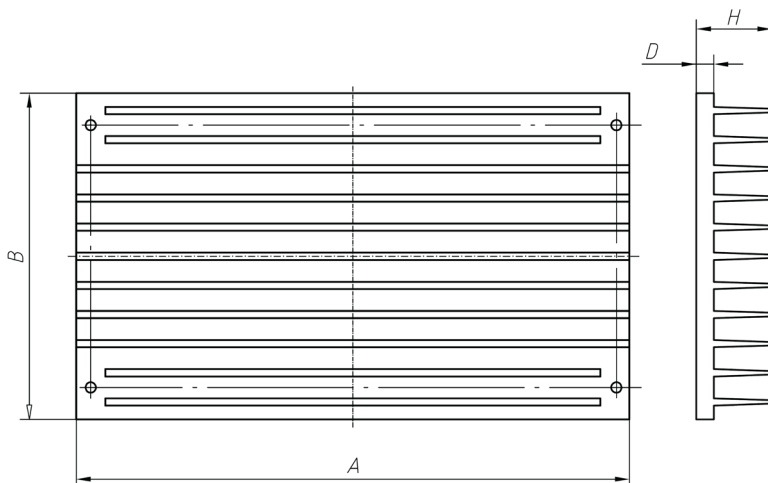

Figure 10. Heatsink with longitudinal ribs for index "i" – 122×82×14×6 mm and index "m" – 122×82×24×6 mm (A×B×H×D).



[eng.aedon.ru](http://eng.aedon.ru)

[mail@aedon.ru](mailto:mail@aedon.ru)

AEDON, LLC is the leading Russian developer and manufacturer of DC/DC converters and power supply systems for critical applications.

Druzinnikov str. 1, Voronezh  
394026, Russia  
+7 473 200-87-80

1, bld. 2, BC "W Plaza 1",  
office A403, Moscow  
101000, Russia  
+7 499 372-50-10

**This datasheet is valid for the following units:** MDVHi320-1N05; MDVHi320-1N12; MDVHi320-1N15; MDVHi320-1N24; MDVHi320-1N28; MDVHi320-1M05; MDVHi320-1M12; MDVHi320-1M15; MDVHi320-1M24; MDVHi320-1M28; MDVHi400-1N12; MDVHi400-1N15; MDVHi400-1N24; MDVHi400-1N28; MDVHi400-1M12; MDVHi400-1M15; MDVHi400-1M24; MDVHi400-1M28; MDVHi500-1N15; MDVHi500-1N24; MDVHi500-1N28; MDVHi500-1M15; MDVHi500-1M24; MDVHi500-1M28; MDVHm320-1N05; MDVHm320-1N12; MDVHm320-1N15; MDVHm320-1N24; MDVHm320-1N28; MDVHm320-1M05; MDVHm320-1M12; MDVHm320-1M15; MDVHm320-1M24; MDVHm320-1M28; MDVHm400-1N12; MDVHm400-1N15; MDVHm400-1N24; MDVHm400-1N28; MDVHm400-1M12; MDVHm400-1M15; MDVHm400-1M24; MDVHm400-1M28; MDVHm500-1N15; MDVHm500-1N24; MDVHm500-1N28; MDVHm500-1M15; MDVHm500-1M24; MDVHm500-1M28.