

## MDV Family

### MDV50 Series

# Multi-purpose compact DC/DC converters

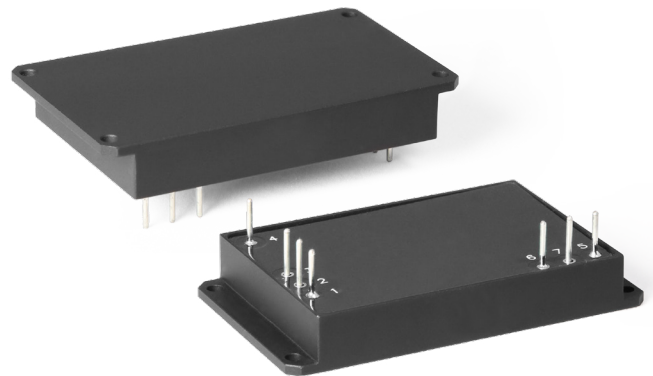

## Description

**Compact isolated DC/DC converters of MDV Series** for industrial and special purpose applications. Despite the small size (57,5×40,2×10,15 mm) the maximum output power of modules reach up 50 W and they are able to operate in a wide case operating temperature range (–60...+125°C). These modules might have single or dual galvanically isolated output, remote on/off, short circuit, overcurrent and thermal protection and can operate in series modes. Without optocouplers in the converter's circuit it can safely operate in conditions of ionizing radiation and high temperature. Power supplies have variable protections from different factors: vibration, dirt, moisture fog and salt fog.

These modules undergo special thermal and limit test including burn-in test with extreme on/off modes.

## Compliance

- MIL-STD-810G
- MIL-STD-461F (CE102)
- MIL-STD-704A-F



Description of MDV Family on the manufacturer's website  
[eng.aedon.ru/pr-universal.php](http://eng.aedon.ru/pr-universal.php)

## Features

- 5 year warranty
- Output current up to 10 A
- 28 VDC input compliant with MIL-STD-704A-F (except Cat. C)
- Low-profile design (10,15 mm) with cylindrical pin outs
- Case operating temperature –60...+125°C
- 125 °C baseplate operation without derating
- Magnetic feedback without optocouplers
- Single and dual output models
- Short circuit protection, overvoltage, thermal protection
- Remote on/off
- Output voltage adjustment
- Typical efficiency 85% (Uout.=24 VDC)
- Polymer potting sealing

### Order registration

+7 473 200 87 80, Global Operations Team

### Technical support

[techsup@aedon.ru](mailto:techsup@aedon.ru)

### Reliability test

[eng.aedon.ru/downloads/documentation/Reliability-Test\\_ENG.pdf](http://eng.aedon.ru/downloads/documentation/Reliability-Test_ENG.pdf)

### 3D models

[www.aedon.ru/content/catalog/docs/201/MDM40V.zip](http://www.aedon.ru/content/catalog/docs/201/MDM40V.zip)

## Ordering information

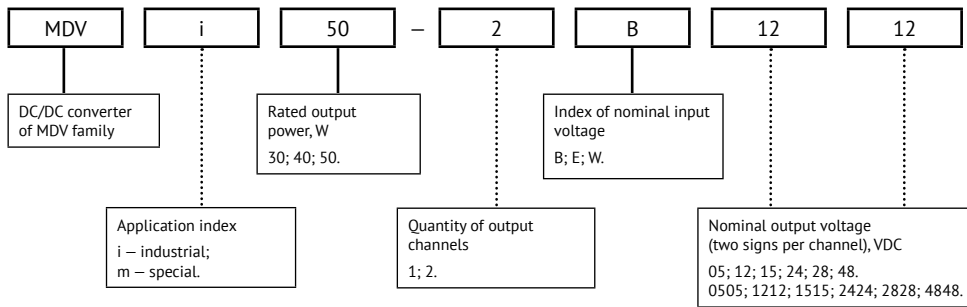

For more information please contact our Global Operations Team

+7 473 200 87 80  
[info@npo-enel.ru](mailto:info@npo-enel.ru)

## Application index

Parameter	Index "m"	Index "i"
Case operating temperature	-60...+125°C	-40...+85°C
Compliance	MIL-STD-810G	+
	EN60950-1	+
	MIL-STD-461F	CE102
	MIL-STD-704A-F	28 VDC input (index "E")
Total regulation (Inom 10–100%)	single channel models	±6%
	dual channel models	±6% output1; ±10% output2
Vibration proof	+	-
Moisture proof (Tamb.=25°C)	98%	60%
Dust proof	+	-
Salt fog resistant	+	-
Typical MTBF	2 000 000 hrs	500 000 hrs
Failure rate	<0,05%	<1%
Warranty	5 years	3 year

## Rated output power and current

Power	30 W						40 W						50 W					
Output voltage, VDC	5	12	15	24	28	48	5	12	15	24	28	48	5	12	15	24	28	48
Rated output current, A	6	2,5	2	1,25	1,07	0,63	8	3,33	2,67	1,67	1,42	0,83	10	4,16	3,3	2,1	1,8	1

Other output voltage within range 3...70 VDC is also available upon special request.

## Index of nominal input voltage\*

Parameter	Index "B"	Index "W"	Index "E"
Nominal input voltage, VDC	12	24	28
Input voltage range, VDC	9...36	18...75	9...36
Transient deviation, VDC	1 s	9...40	-
	10 s	-	8...80
Typical efficiency for Uout.=24 VDC	85%	85%	85%

\* Reflected input ripple current (10–10000 Hz) – 8% Uin. nom

## Specifications

All specifications valid for normal climatic conditions (ambient temp. 15...35°C; relative humidity 45...80%; air pressure 8,6\*10<sup>4</sup>...10,6\*10<sup>4</sup> Pa), U<sub>in</sub>. nom, I<sub>out</sub>. nom, unless otherwise stated. It is important to note that the information herein is not full. More detailed information (specific requirements, basic connection circuits, operating instructions etc.) can be found on our web-site: [eng.aedon.ru](http://eng.aedon.ru)

### Output specifications

Parameter		Value
Output voltage adjustment of single channel models		5% U <sub>out</sub> . nom
Total regulation	Input voltage variation (U <sub>min</sub> ...U <sub>max</sub> )	max ±2%
	Load variation (10...100% I <sub>max</sub> )	
Ripple and noise (p-p)		<2% U <sub>out</sub> . nom
Maximum capacitive load	5 VDC	2700 uF
	12 VDC	250 uF
	24 VDC	55 uF
	48 VDC	27 uF
Start up time (remote)		max 0,1 s
Overload protection level*	30 W	<3 P <sub>max</sub>
	40 W	<2,2 P <sub>max</sub>
	50 W	<1,8 P <sub>max</sub>
Short circuit protection*		hiccup auto recovery
Overvoltage protection		1,5 U <sub>nom</sub>

\* Parameters are stated for the information purposes and could not be used at long term work, exciding maximum output current, at work outside of a range of operating temperatures.

### General specifications

Parameter		Value
Case temperature	Operating (natural convection) – power derating (natural convection) – without power derating with heatsink	–60...+125°C see power derating diagram (dashed, dash-dotted curve) see power derating diagram (solid curve)
	Storage	–60...+125°C
Switching frequency		290–310 kHz
Isolation capacitance	input/output	1500 pF
Isolation voltage (60 s)	input/output, input/case, output/case	500 VAC
Isolation resistance @ 500 VDC	input/output, input/case, output/case	20 MOhm min
Thermal impedance		7,8°C/W
Thermal protection level		118...125°C, clamp, auto recovery
Remote on/off		Off.: connection of pins "ON" and "–IN", I <sub>s</sub> ≤ 5 mA

## Specifications (cont.)

### Physical specifications

Parameter	Value
Case material	aluminium
Potting	epoxy polimer
Pin material	phosphor bronze, SnP8 plated
Weight	max 65 g
Soldering temperature	260°C @ 5 s

### Design topology

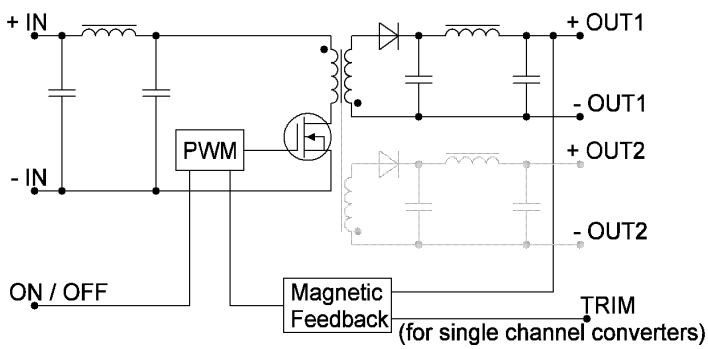

Figure 1. Design topology.

## Service functions

### Typical connection

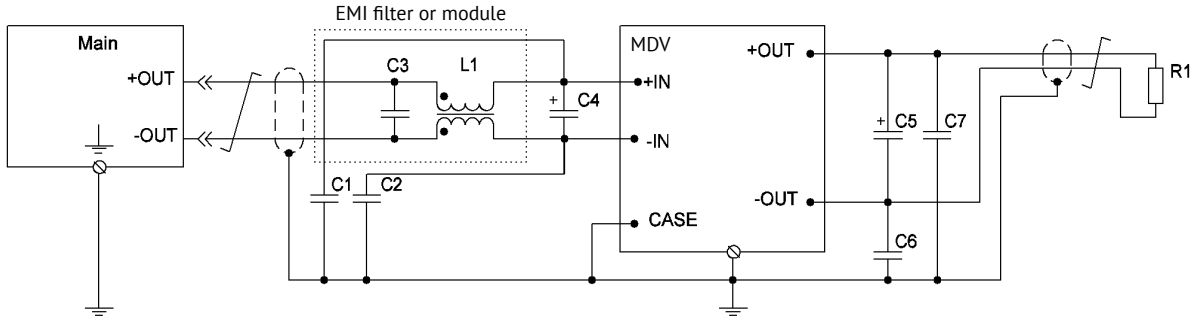

Figure 2. Design topology with filtration unit.

C1, C2, C6, C7		ceramic capacitor		100...4700 pF 500 VDC min
C4		tantalum capacitor	Input voltage	12 VDC 24 (28) VDC
C5		tantalum capacitor	Output voltage	5 VDC 12 VDC 24 VDC 48 VDC
EMI Filter	L1	common mode choke		8 mH
	C3	ceramic capacitor	Input voltage	12 VDC 24 (28) VDC
EMI Module	M series	Double Pi filter EMI module. See datasheet M Series	Maximum current up to 20 A, overvoltage and surge protection, loss insertion up to 60 db	

## Service functions (cont.)

### Remote control

Function of remote control by a signal allows to control the unit's operation using mechanical relay or electric switch of "open collector" type.

The unit should be powered off by connecting "ON" output to "-IN" output. The switch can carry current of up to 5 mA, the max voltage drop on the switch should be less than 1,1 V.

The unit is powered on by disconnecting the switch within the time less then 5  $\mu$ s. Being disconnected the switch is applied by approximately 5 V, allowable current leakage through the switch should not be over 50  $\mu$ A.

To arrange remote power off/on of several units simultaneously it is not allowed to use additional elements in the circuit to connect outputs "ON" and "-IN" and a switch.

If the function of remote power off/on is not used, "ON" output is allowed to be left unconnected.

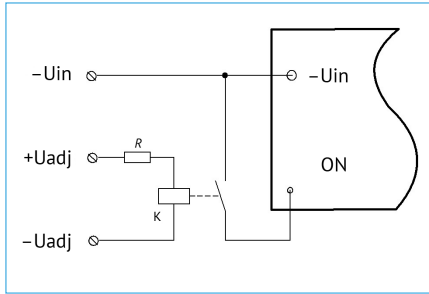

Figure 3 (a). Layout of mechanical relay control.

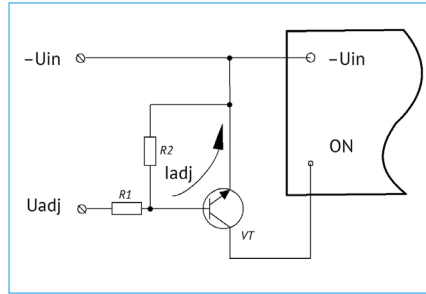

Figure 3 (b). Layout of bipolar transistor control.

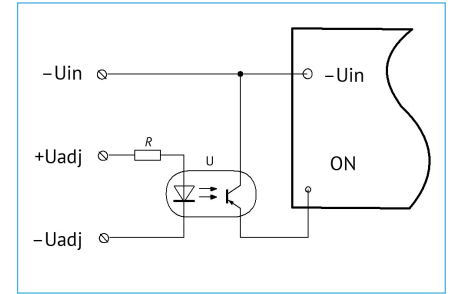

Figure 3 (c). Layout of optocoupler control.

### Adjustment

Adjustment of output voltage of a power supply unit within the range of at least  $\pm 5\%$  can be done by connecting "TRIM" output (if available) through "-OUT" output to increase output voltage, or through "+OUT" output to decrease the output voltage.

In case of using variable resistor Rvar and outside resistors (R1, R2) it is possible to fulfill the adjustment both to increase and decrease the output voltage.

If you need to control the output voltage of a power supply unit by a signal from external source of current or voltage, e.g. in micro-controller automated control systems using DAC, the external current or voltage signal should be supplied to the adjustment output relating to "-OUT" output, as shown in the drawings (b) and (c).

Calculation formula of nominal values of circuit elements (a), current (b) and voltage (c) can be found in Technical Guides available on [www.eng.aedon.ru](http://www.eng.aedon.ru).

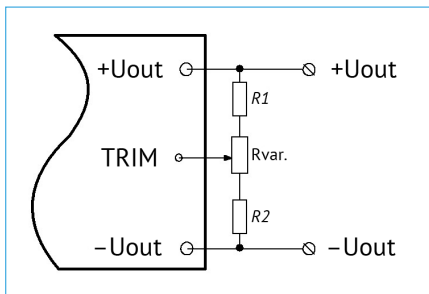

Figure 4 (a).

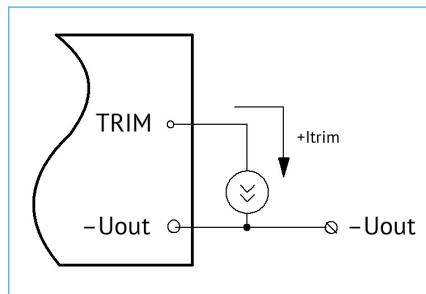

Figure 4 (b).

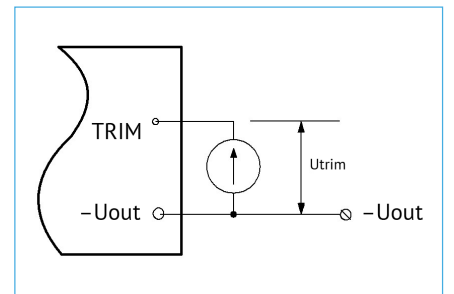

Figure 4 (c).

## Service functions (cont.)

### Output voltage VS resistor rating

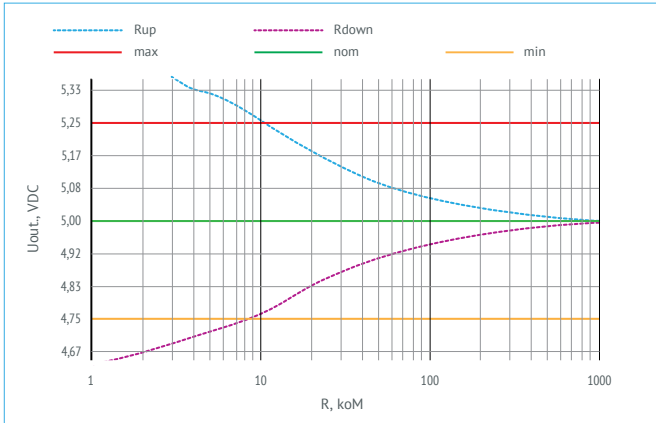

Figure 5 (a). Current and voltage values for adjustment of MDVx50-xx05.

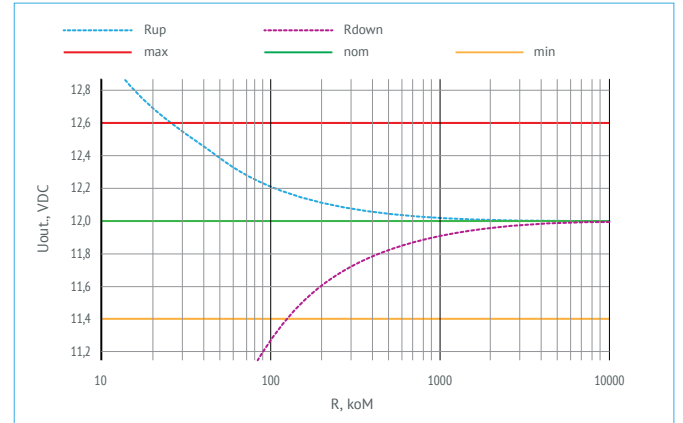

Figure 5 (b). Current and voltage values for adjustment of MDVx50-xx12.

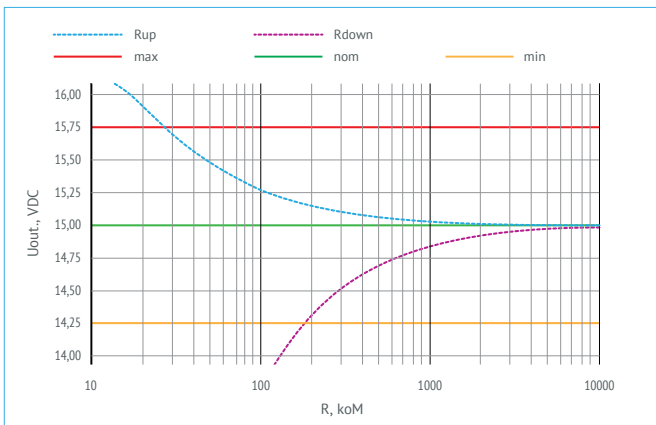

Figure 5 (c). Current and voltage values for adjustment of MDVx50-xx15.

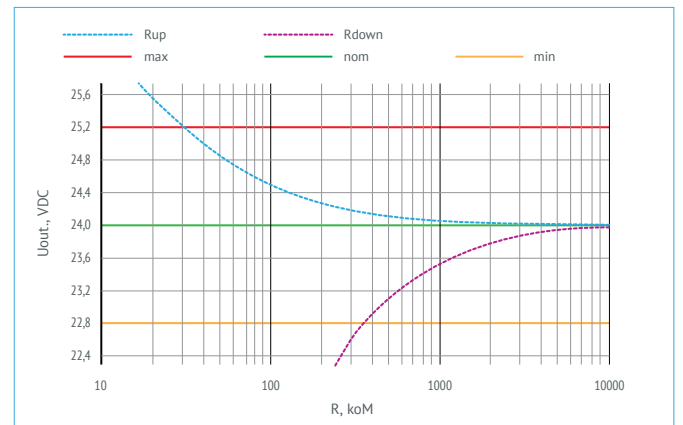

Figure 5 (d). Current and voltage values for adjustment of MDVx50-xx24.

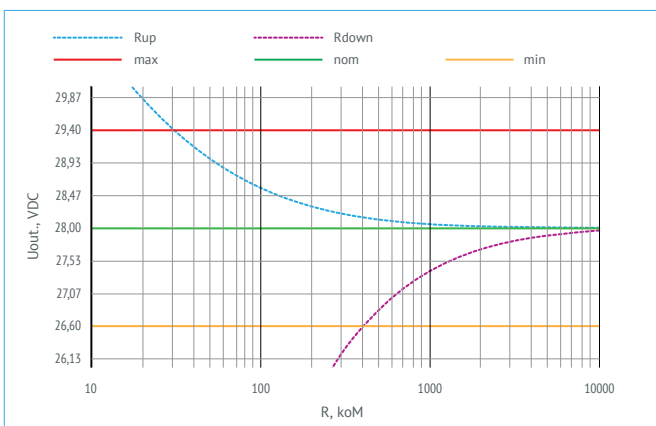

Figure 5 (e). Current and voltage values for adjustment of MDVx50-xx28.

## Efficiency

### VS load

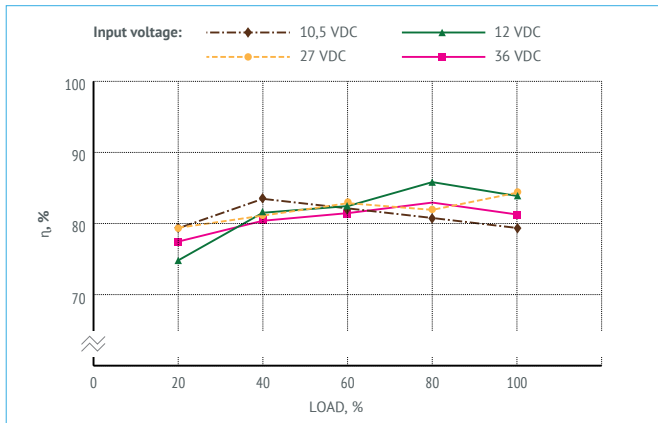

Figure 6 (a). Efficiency of MDVx50-1B05.

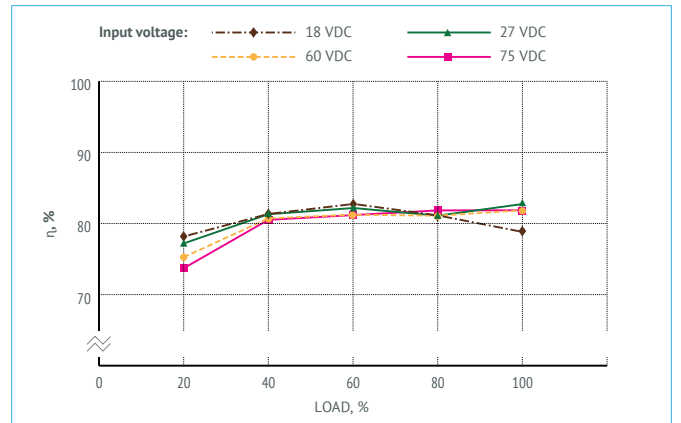

Figure 6 (b). Efficiency of MDVx50-1W05.

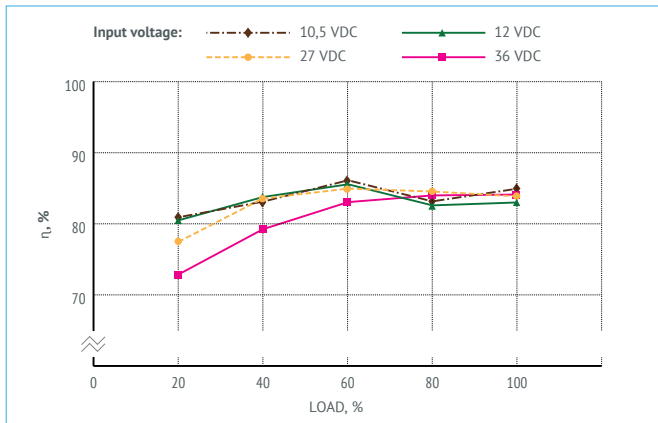

Figure 6 (c). Efficiency of MDVx50-1B27.

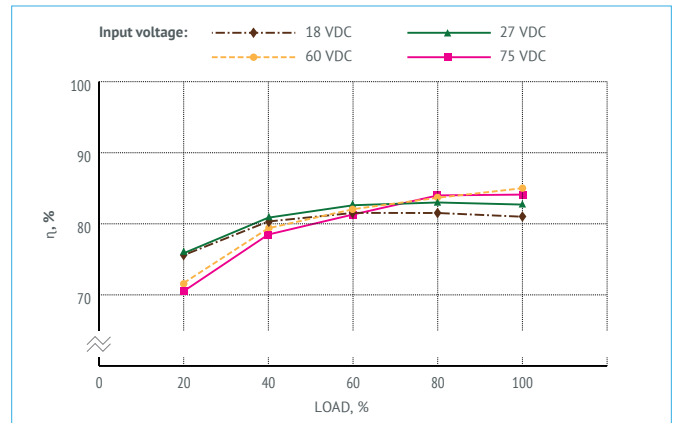

Figure 6 (d). Efficiency of MDVx50-1W27.



## Power derating

### VS ambient temperature and baseplate temperature

The PSU is able to operate with 100% load within the complete range of case operating temperature (-60...+125 °C). On condition the case temperature is kept from -60°C to 125 °C the PSU will operate without derating regardless of the ambient temperature. Thermal Management section of the Application Notes shows the resulting heatsink area, as well as baseplate-vs-ambient thermal resistance, the min thickness of the heatsink, and the max PSU output power without heatsink.

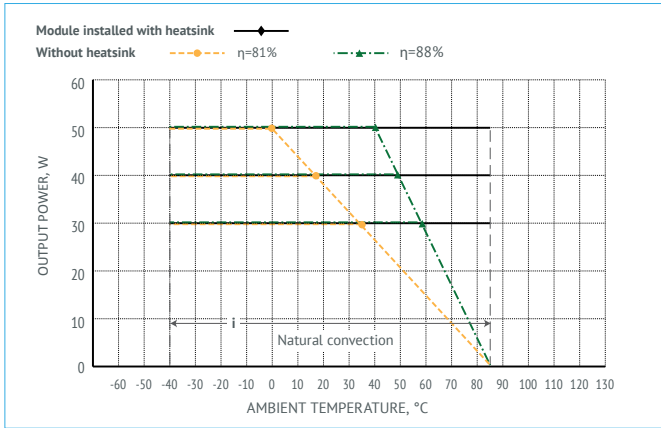

Figure 7 (a). Power derating of MDVi50-xxx.

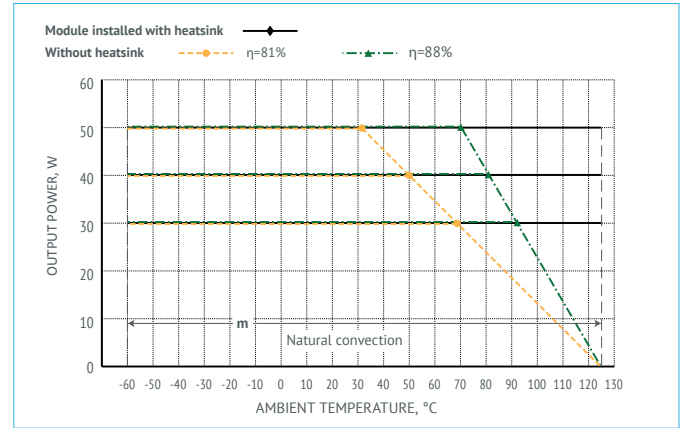
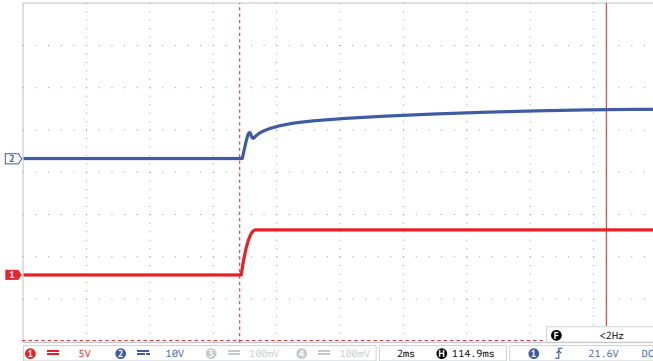

Figure 7 (b). Power derating of MDVm50-xxx.

## Oscillograph charts of MDVx50-xxx

Testing conditions  $U_{in}=12$  VDC,  $I_{out}=4.16$  A,  $T_{amb}=25^{\circ}\text{C}$ ,  $U_{out}=12$  VDC,  $C_{out}=100$  uF

The database of regulated parameters of the manufactured products is available. Pls. contact your personal manager or customer support service to get necessary information.

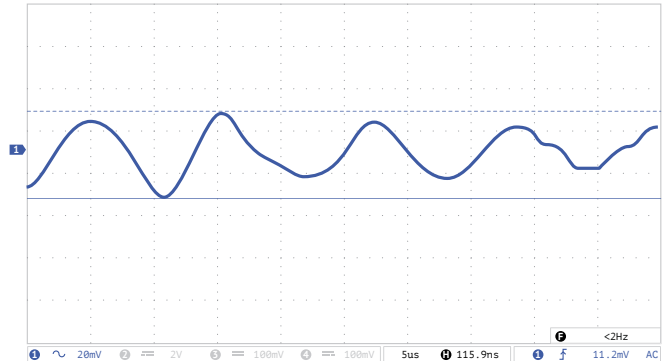

**Figure 8 (a).** Oscillograph chart of setting output voltage after supplying remote control signal to ON-output.

Ray 1 (red) – output voltage. Scale 5 V/div.

Ray 2 (blue) – voltage at ON-output. Scale 10 V/div.

Time scale  $t=2$  ms/div.



**Figure 8 (c).** Oscillograph chart of output voltage ripple.

Ray 1 (blue) – ripple of output voltage. Scale 20 mV/div.

Time scale 5 us/div.

Measuring technique: see Electrical Test Screen.



**Figure 8 (d).** Oscillograph chart of voltage transient deviation during load “drop/rise”.

Ray 1 (blue) – output voltage. Scale 2 V/div.

Time scale  $t=20$  ms/div.

Modes:

- “drop” output current variation (10...100%)  $I_{nom}$ ;
- “rise” output current variation (10...100%)  $I_{nom}$ ;
- build-up time 500 us.

## Noise spectrogram

Testing according to MIL-STD-461F CE102. (Tcase=25°C, Vin.=+12 V, full load, unless otherwise specified)

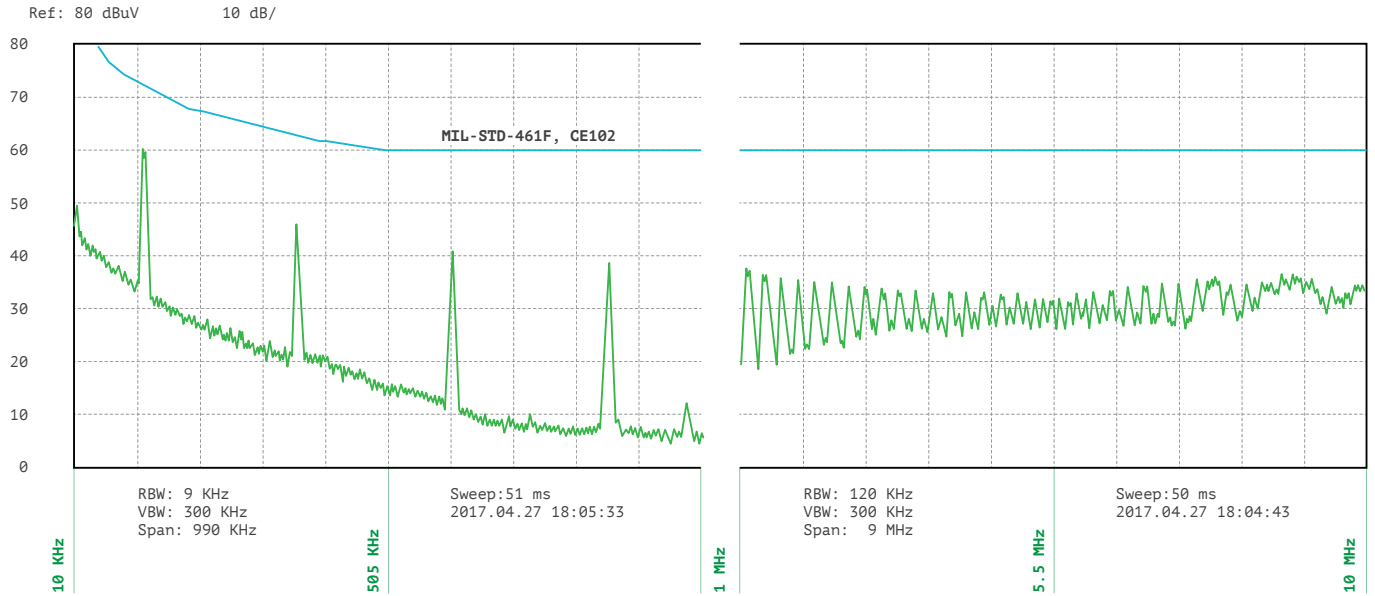

Figure 9. Spectrogram of MDV40-1W12 with typical connection diagram.

## Outline dimensions

### Models packed in reinforced case with flanges

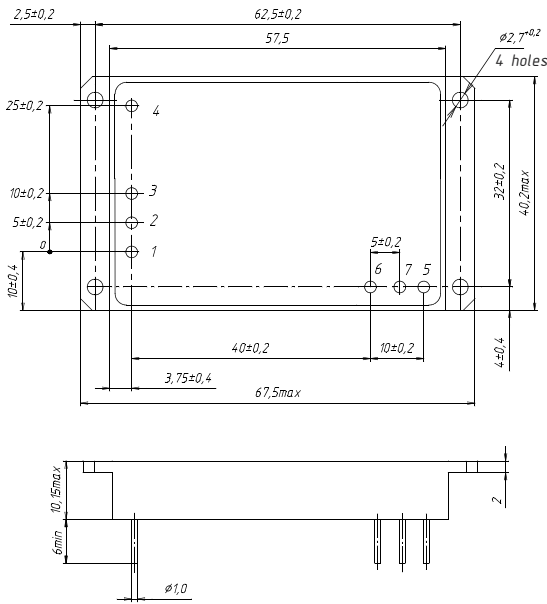

Figure 10 (a). Single-output models.

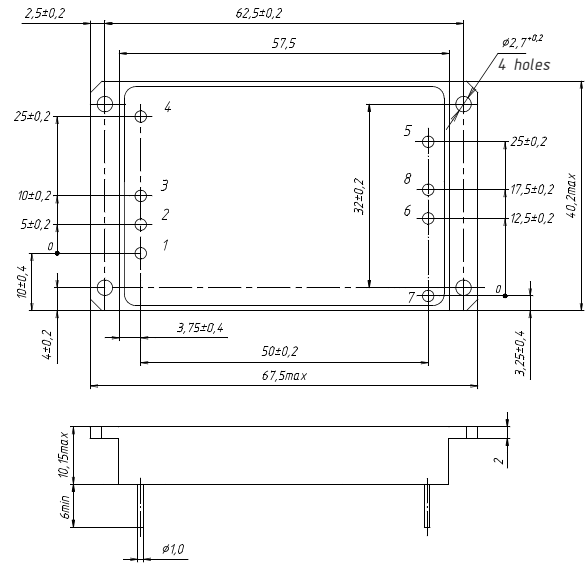

Figure 10 (b). Dual-output models.

### Pin out

Pin #	1	2	3	4	5	6	7	8
Single channel	CASE	+IN	-IN	ON	+OUT	-OUT	TRIM	-
Dual channel	CASE	+IN	-IN	ON	+OUT1	+OUT2	-OUT2	-OUT1

## Accessories

### Heatsink

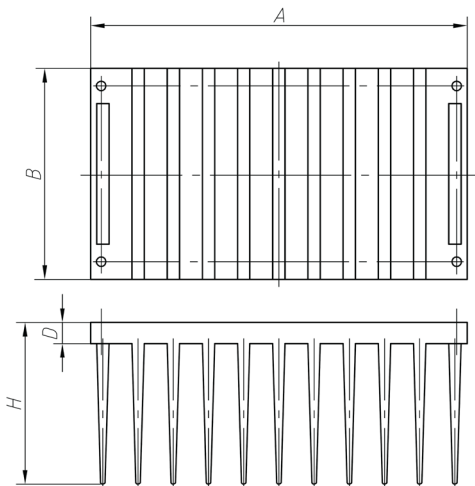

Figure 11 (a). Heatsink with transversal ribs for index "i" – 67,5×40×14×4 mm and index "m" – 67,5×40×24×4 mm (A×B×H×D).

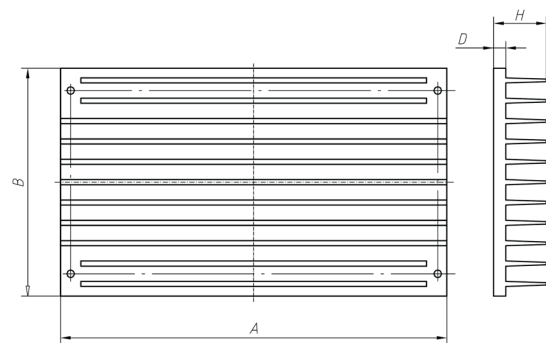

Figure 11 (b). Heatsink with longitudinal ribs for index "i" – 67,5×40×14×4 mm and index "m" – 67,5×40×24×4 mm (A×B×H×D).



[eng.aedon.ru](http://eng.aedon.ru)

[mail@aedon.ru](mailto:mail@aedon.ru)

AEDON, LLC is the leading Russian developer and manufacturer of DC/DC converters and power supply systems for critical applications.

Druzinnikov str. 1, Voronezh  
394026, Russia  
+7 473 200-87-80

1, bld. 2, BC "W Plaza 1",  
office A403, Moscow  
101000, Russia  
+7 499 372-50-10

**This datasheet is valid for the following units:** MDVi30-1B05; MDVi30-1B12; MDVi30-1B15; MDVi30-1B24; MDVi30-1B28; MDVi30-1E05; MDVi30-1E12; MDVi30-1E15; MDVi30-1E24; MDVi30-1E28; MDVi30-1W05; MDVi30-1W12; MDVi30-1W15; MDVi30-1W24; MDVi30-1W28; MDVi40-1B05; MDVi40-1B12; MDVi40-1B15; MDVi40-1B24; MDVi40-1B28; MDVi40-1E05; MDVi40-1E12; MDVi40-1E15; MDVi40-1E24; MDVi40-1E28; MDVi40-1W05; MDVi40-1W12; MDVi40-1W15; MDVi40-1W24; MDVi40-1W28; MDVi50-1B05; MDVi50-1B12; MDVi50-1B15; MDVi50-1B24; MDVi50-1B28; MDVi50-1E05; MDVi50-1E12; MDVi50-1E15; MDVi50-1E24; MDVi50-1E28; MDVi50-1W05; MDVi50-1W12; MDVi50-1W15; MDVi50-1W24; MDVi50-1W28; MDVm30-1B05; MDVm30-1B12; MDVm30-1B15; MDVm30-1B24; MDVm30-1B28; MDVm30-1E05; MDVm30-1E12; MDVm30-1E15; MDVm30-1E24; MDVm30-1E28; MDVm30-1W05; MDVm30-1W12; MDVm30-1W15; MDVm30-1W24; MDVm30-1W28; MDVm40-1B05; MDVm40-1B12; MDVm40-1B15; MDVm40-1B24; MDVm40-1B28; MDVm40-1E05; MDVm40-1E12; MDVm40-1E15; MDVm40-1E24; MDVm40-1E28; MDVm40-1W05; MDVm40-1W12; MDVm40-1W15; MDVm40-1W24; MDVm40-1W28; MDVm50-1B05; MDVm50-1B12; MDVm50-1B15; MDVm50-1B24; MDVm50-1B28; MDVm50-1E05; MDVm50-1E12; MDVm50-1E15; MDVm50-1E24; MDVm50-1E28; MDVm50-1W05; MDVm50-1W12; MDVm50-1W15; MDVm50-1W24; MDVm50-1W28; MDVi30-2B0505; MDVi30-2B1212; MDVi30-2B1515; MDVi30-2B2424; MDVi30-2B2828; MDVi30-2E0505; MDVi30-2E1212; MDVi30-2E1515; MDVi30-2E2424; MDVi30-2E2828; MDVi30-2W0505; MDVi30-2W1212; MDVi30-2W1515; MDVi30-2W2424; MDVi30-2W2828; MDVi40-2B0505; MDVi40-2B1212; MDVi40-2B1515; MDVi40-2B2424; MDVi40-2B2828; MDVi40-2E0505; MDVi40-2E1212; MDVi40-2E1515; MDVi40-2E2424; MDVi40-2E2828; MDVi40-2W0505; MDVi40-2W1212; MDVi40-2W1515; MDVi40-2W2424; MDVi40-2W2828; MDVi50-2B0505; MDVi50-2B1212; MDVi50-2B1515; MDVi50-2B2424; MDVi50-2B2828; MDVi50-2E0505; MDVi50-2E1212; MDVi50-2E1515; MDVi50-2E2424; MDVi50-2E2828; MDVi50-2W0505; MDVi50-2W1212; MDVi50-2W1515; MDVi50-2W2424; MDVi50-2W2828; MDVm30-2B0505; MDVm30-2B1212; MDVm30-2B1515; MDVm30-2B2424; MDVm30-2B2828; MDVm30-2E0505; MDVm30-2E1212; MDVm30-2E1515; MDVm30-2E2424; MDVm30-2E2828; MDVm30-2W0505; MDVm30-2W1212; MDVm30-2W1515; MDVm30-2W2424; MDVm30-2W2828; MDVm40-2B0505; MDVm40-2B1212; MDVm40-2B1515; MDVm40-2B2424; MDVm40-2B2828; MDVm40-2E0505; MDVm40-2E1212; MDVm40-2E1515; MDVm40-2E2424; MDVm40-2E2828; MDVm40-2W0505; MDVm40-2W1212; MDVm40-2W1515; MDVm40-2W2424; MDVm40-2W2828; MDVm50-2B0505; MDVm50-2B1212; MDVm50-2B1515; MDVm50-2B2424; MDVm50-2B2828; MDVm50-2E0505; MDVm50-2E1212; MDVm50-2E1515; MDVm50-2E2424; MDVm50-2E2828; MDVm50-2W0505; MDVm50-2W1212; MDVm50-2W1515; MDVm50-2W2424; MDVm50-2W2828.