



MIL-STD-461 EMI INPUT FILTER FGDS-10A-50V : up to 10A CURRENT

Hi-Rel
Grade ■■

10A EMI Filter Module 9 to 50 VDC Input Range MIL-STD-461D/E/F & DO-160C/D/E/F/G Compliant



- To comply with MIL-STD-461D/E/F power leads :
 - CE 102 : Emission requirement over 10 KHz to 10MHz
 - CS 101 : Susceptibility requirement over 30Hz to 150KHz
 - CS 114 : Susceptibility requirement over 10KHz to 400MHz
 - CS 115 : Susceptibility requirement for spikes
- To comply with DO-160C/D/E/F/G power lines :
 - Conducted emission requirement over 15 KHz to 152MHz
 - Conducted susceptibility requirement over 10Hz to 400MHz
- Temperature range :
 - operating temperature : -40°C/+105°C case
 - storage temperature : -55°C/+125°C
- RoHS process

1-General

The GAIA Converter filter module FGDS-10A-50V provides a state-of-the-art product to fulfill Electromagnetic Interferences (EMI) requirements for Aerospace and Defence applications.

The FGDS-10A-50V is a very compact and low loss solution for applications requiring up to 10A input current.

The FGDS-10A-50V complies with major standards including :

- the US MIL-STD-461 rev D, E and rev F
- the international DO-160 rev C, D, E, F & rev G.

In particular, the filter module is compliant with the following requirements of MIL-STD-461D/E and DO-160-C/D/E standards :

- **MIL-STD-461D/E/F Part 2. & 3. requirements :**
 - **Conducted Emission (CE)**
 - CE102, power leads, emission over 10KHz to 10MHz, basic curve
 - **Conducted Susceptibility (CS)**
 - CS101, power leads, frequency 30Hz to 150KHz, curve #1,
 - CS114, bulk cable injection, frequency 10KHz to 400MHz,

- CS115, spikes, bulk cable injection calibrated spike
- CS116, damped sinusoidal transient
- **DO-160-C/D/E/F/G requirements :**
 - **Conducted Emission (CE)**
 - Section 21 power lines, emission over 15KHz to 152MHz, category B, AZ & LMH
 - **Conducted Susceptibility (CS)**
 - Section 20 power lines, frequency 10KHz to 400MHz

In addition, this filter withstands in a transparent state without damage the transient requirements of :

- MIL-STD-704A/D/E/F with up to 80V/100ms
- MIL-STD-1275A/B/C/D with up to 100V/50ms

The FGDS-10A-50V is suitable for all GAIA Converter DC/DC converters and DC architecture

- from 25W up to 150W output power
- up to 10A output current
- up to 50V permanent input voltage.

2-Product Selection

FGDS-10A-50V / option

Options :

- /T : option for -55°C start up operating temperature
- /S : option for screening and serialization

6

3- Electrical Specifications

Data are valid at +25°C, unless otherwise specified.

Parameter	Conditions	Limit or typical	Units	FGDS-10A-50V
Input				
Nominal input voltage	Full temperature range	Nominal	VDC	28
Permanent input voltage range (Ui)	Full temperature range	Min. - Max.	VDC	9 - 50
Transient input voltage	Full temperature range Full load	Maximum	VDC/ms	80/100
		Maximum	VDC/ms	100/50
Output				
Permanent output current	Full temperature range up to 105°C case Ui min. to max.	Maximum	A	10
Permanent output power	Full temperature range up to 105°C case Ui min. to max.	Maximum	W	150
Power dissipation	Current 10A @ 25°C Current 10A @ 85°C	Maximum	W	1
		Maximum	W	1,4
Thermal resistance	Case to ambient in free air cooling	Nominal	°C/W	16
General				
Electrical strength test voltage	Case to any pin Gnd pin to any other pin	Minimum	VDC	500
		Minimum	VDC	500
Reliability data MTBF according MIL-HDBK-217F	Conditions Gf	@40°C	Hours	27 000 000
		@85°C	Hours	7 000 000
	Conditions AIC	@40°C	Hours	13 000 000
		@85°C	Hours	3 500 000
EMI compliance				
Conducted emission	Power leads	MIL-STD-461D/E/F	CE102	See section 6
	Power lines	DO-160C cat B & AZ	Section 21	See section 6
	Power lines	DO-160D/E/F/G cat B & LMH	Section 21	See section 6
Conducted susceptibility	50 Ohm impedance	MIL-STD-461D/E/F	CS115	Compliant
	Imax = 10A	MIL-STD-461D/E/F	CS116	Compliant
	10KHz to 400MHz	DO-160C/D/E/F/G	Section 20	Compliant

4- EMI Filter Electrical Schematics

The GAIA Converter FGDS-10A-50V is suitable for all GAIA Converter DC/DC converters and combinations :

- from 25W up to 150W total output power and up to 10A output current
- up to 50V permanent input voltage and up to 100V transient input voltage during 50ms.

4-1 EMI Filter Electrical Schematics in Front of Modules

The GAIA Converter FGDS-10A-50V can be used directly in front of any DC/DC converter and combination of DC/DC converters from 50W up to 200W power and up to 10A input current.

In order to exceed the EMI requirements of MIL-STD-461D/E/F or DO-160C/D/E/F/G it is recommended to use 2x FGDS-10A-50V in series as shown in the following figure.

Configuration with one FGDS-10A-50V in certain case can be implemented : please consult factory.

For better EMI performance and stability purpose GAIA Converter recommends to use a R*C* cell (see section 4) together with decoupling capacitors (10nF typical) connected to the converters as it is detailed in individual DC/DC converter datasheet.

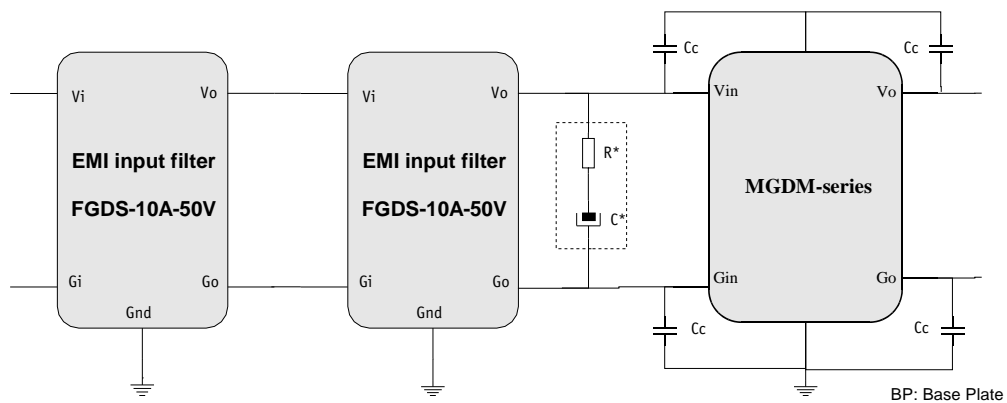

4-2 EMI Filter Electrical Schematics in a Complete Front-end Architecture

The GAIA Converter FGDS-10A-50V can be used in a complete architecture combining transient protection module LGDS series and combination of DC/DC converters. In order to exceed the EMI requirements of MIL-STD-461D/E/F or DO-160C/D/E/F/G it is recommended to use 2x FGDS-10A-50V directly in series up front as shown in the following figure.

Configuration with one FGDS-10A-50V in certain case can be implemented : please consult factory

For better EMI performance and stability purpose GAIA Converter recommends to use a R*C* cell (see section 4-3) (together with individual DC/DC decoupling capacitors as detailed in individual DC/DC converter datasheet).

This schematics is designed to propose a solution to achieve :

- EMI filtering compliant with conducted emission
- transient protection

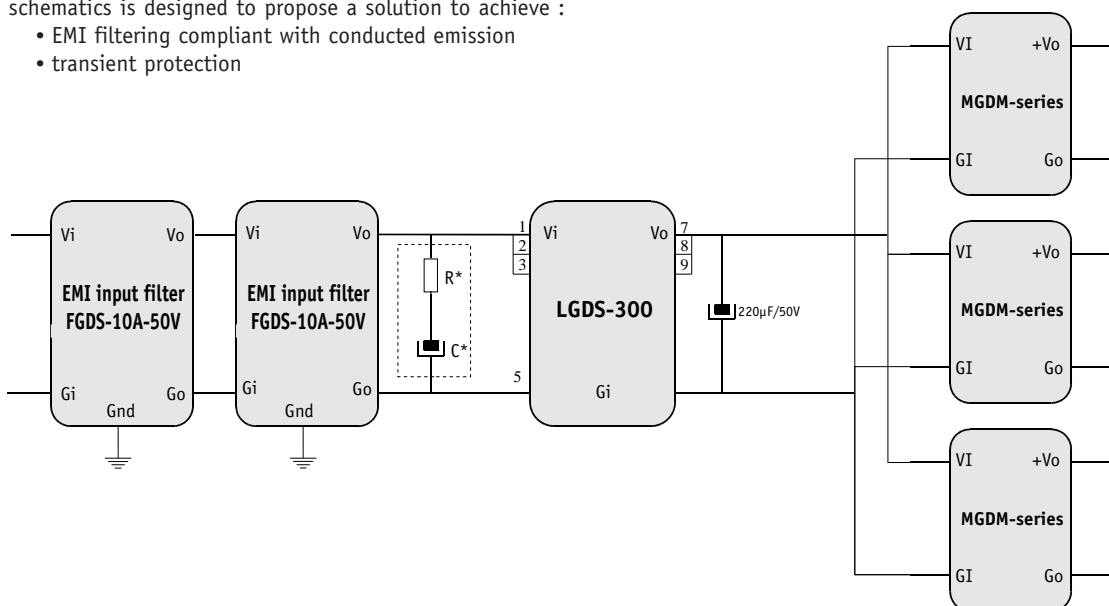

4- EMI Filter Electrical Schematics (continued)

4-3 R*C* Network Discussion

The RC damping network is used for stability purposes in negative input impedance systems such as DC/DC converters.

DC/DC converters are negative input impedance systems whereas, filters are composed of passive elements and display a positive output impedance to the converter.

To ensure the stability of the whole system "LISN + input Filter + DC/DC converters", the filter output impedance must be kept below the converter's input impedance, which is given by the following formula :

$$Z_{in} = \frac{V_{in}^2}{P_{in}} = \frac{V_{in}^2 \times \eta}{P_o}$$

where :

- V_{in} is the converter input voltage,
- P_{in} is the converter input power,
- P_o is the converter output power
- η is the efficiency of the converter.

As it can be seen from the preceding equation, the worst case for system's stability is at $V_{in_{min}}$, so this is the condition which should be considered for the filter design.

As the filter is made of low ESR inductors and ceramic capacitors, it has an important quality factor Q which causes a sharp increase of the filter's output impedance at the resonant frequency and leads to a violation of the stability criteria, causing the system to break into oscillations.

Consequently, the values of RC network has to be adjusted to dampen sufficiently the filter's resonance and make its output impedance lower than the converter's input impedance.

The value of the RC network strongly depends on the application's conditions (input voltage range and total power drawn from the source as well as the standards that the equipment has to meet MIL-STD-461 or DO-160 ...) this because measurements method (LISN) differs from one standard to another affecting the C value.

In most applications a low ESR aluminium electrolytic capacitor can be used for damping the network and it's **internal ESR value will be enough to dampen the input voltage without adding external resistor.**

The table hereafter summarizes the recommended capacitor value at 100% output load for various power according to DO160 and to MIL-STD-461 standards. The capacitor value can be linearly reduced depending on output power; for example, it can be divided by 2 at 50 % load...

Total Power	75W	100W	150W	200W	300W
Capacitor Value for MIL-STD-461 standards	330 μ F	470 μ F	470 μ F	680 μ F	1 000 μ F
Capacitor Value for DO-160 standards	100 μ F	100 μ F	220 μ F	220 μ F	330 μ F

5- MIL-STD-461D/E/F Conducted Emission Tests Set-Up

5-1 MIL-STD-461D/E/F Measurement Method

The conducted noise emission measurement method is described in the MIL-STD-461D/E/F standards.

The «DUT» (Device Under Test) is powered thru a 2 meters length parallel wire.

One end is terminated with the DUT and the other end is terminated with LISN networks.

The measurements are made with a measurement receiver, the unit being dB μ V

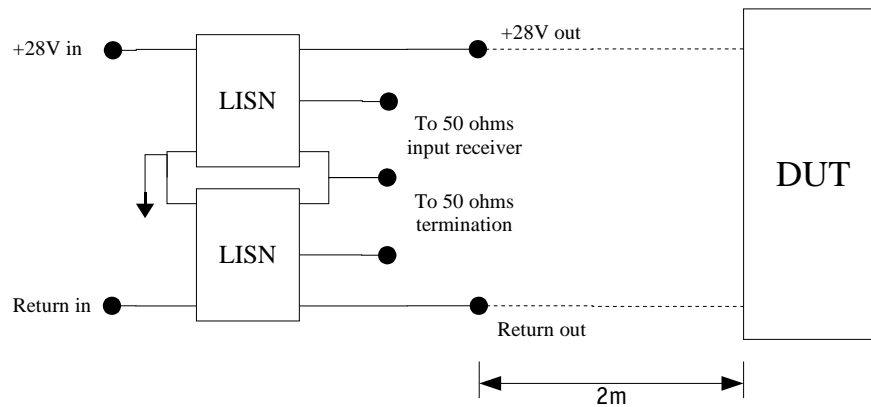

6- MIL-STD-461E Conducted Emission Level Results

MIL-STD-461E : MGDS-75-H-F with FGDS-10A-50V

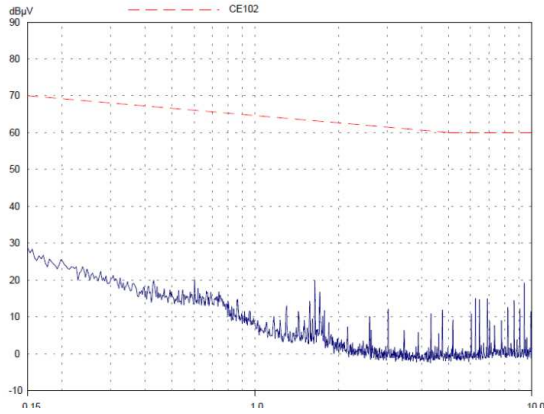

MIL-STD-461E : MGDS-100-M-26 with FGDS-10A-50V

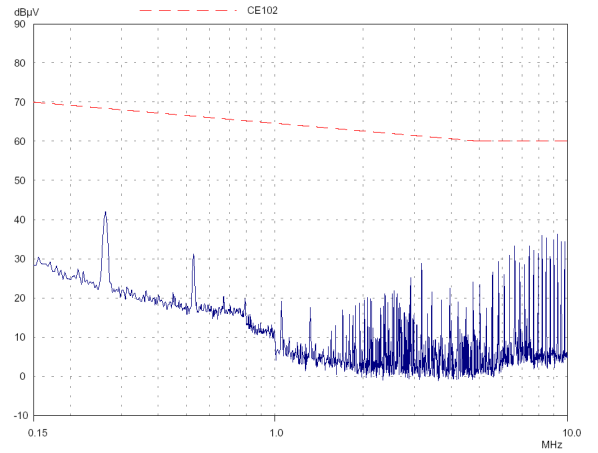

MIL-STD-461E : MGDS-150-H-J with FGDS-10A-50V

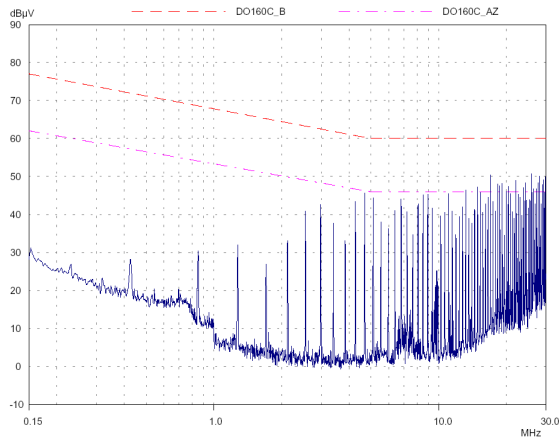

MIL-STD-461E : 2 x MGDS-75-H-J with FGDS-10A-50V

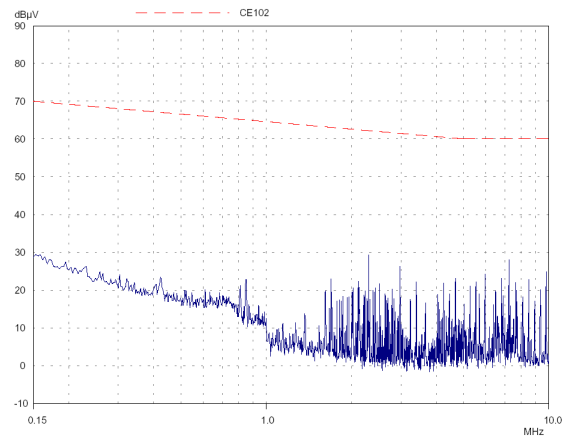

6- DO-160C Conducted Emission Level Results

DO-160C : MGDS-75-H-F with FGDS-10A-50V

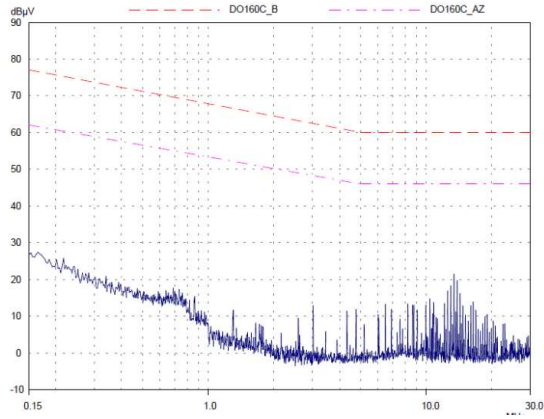

DO-160C : MGDS-75-O-C with FGDS-10A-50V

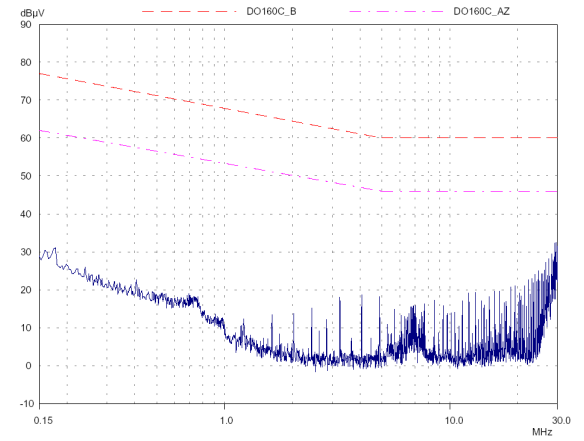

DO-160C : MGDS-100-M-26 with FGDS-10A-50V

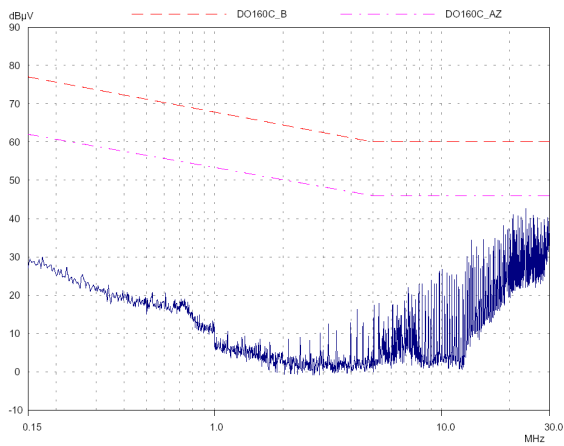

DO-160C : MGDS-150-H-J with FGDS-10A-50V

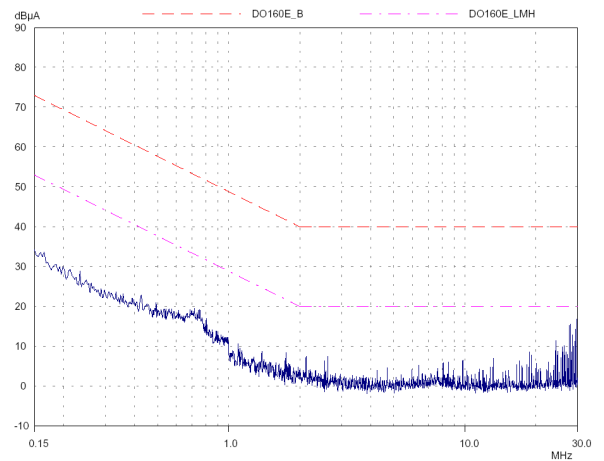

6

6- D0-160E Conducted Emission Level Results

D0-160E : MGDS-75-H-F with FGDS-10A-50V

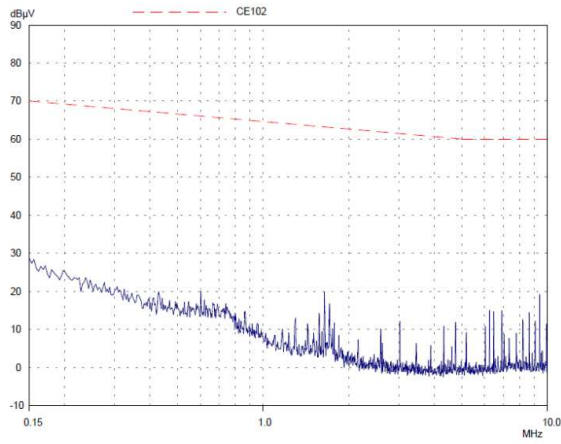

D0-160E : MGDS-75-0-C with FGDS-10A-50V

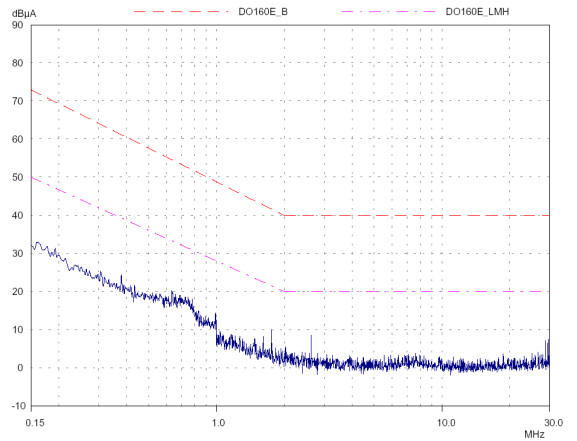

D0-160E : MGDS-100-M-26 with FGDS-10A-50V

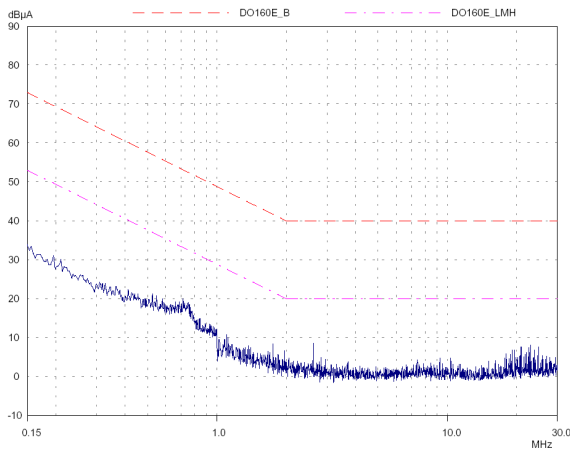

D0-160E : MGDS-150-H-J with FGDS-10A-50V

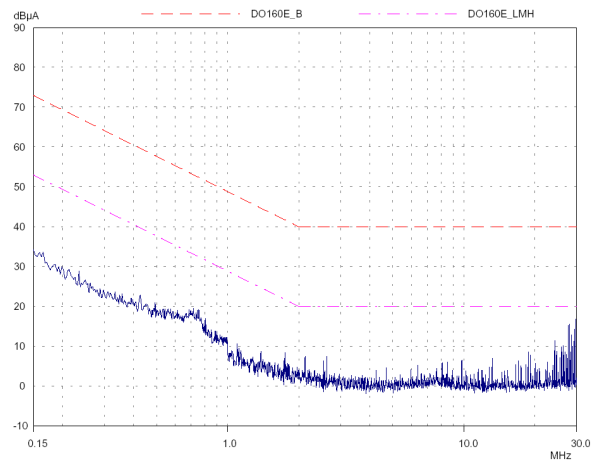

6

6- D0-160G Conducted Emission Level Results

D0-160G : MGDS-75-H-F with FGDS-10A-50V

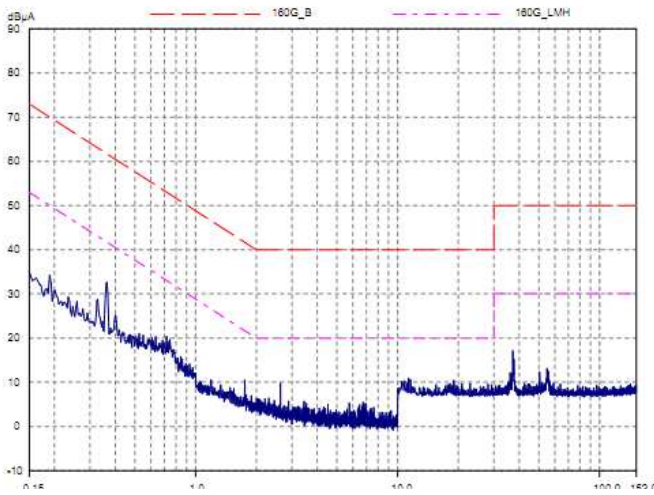

D0-160G : MGDS-75-O-J with FGDS-10A-50V

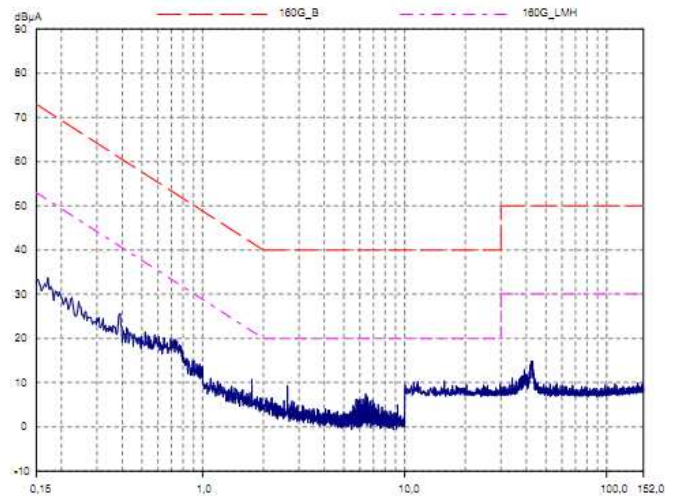

D0-160G : MGDS-150-H-C with FGDS-10A-50V

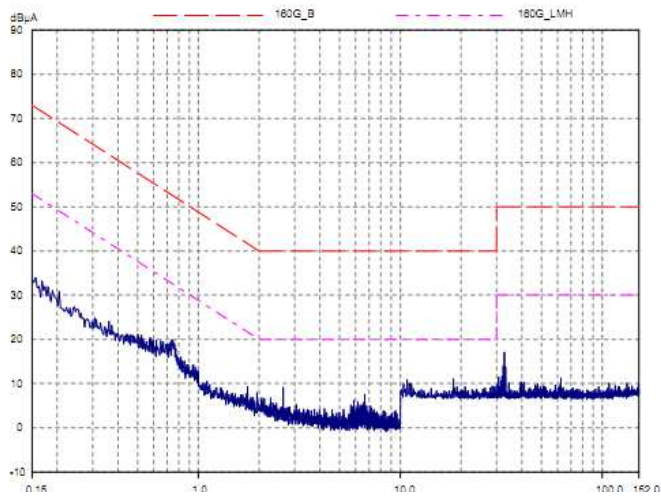

D0-160G : MGDS-150-H-J with FGDS-10A-50V

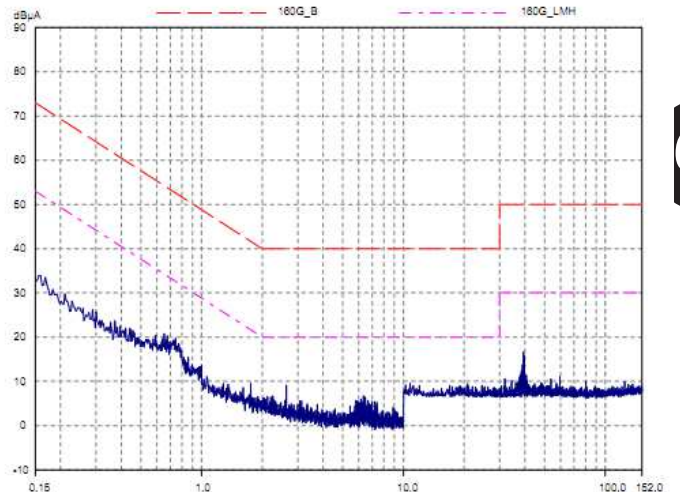

7- Environmental Qualifications

The modules have been subjected to the following environmental qualifications.

Characteristics	Conditions	Severity	Test procedure
Climatic Qualifications			
Life at high temperature	Duration Temperature / status of unit	Test D : 1 000 Hrs @ 105°C case, unit operating @ 125°C ambient, unit not operating	MIL-STD-202G Method 108A
Altitude	Altitude level C Duration Climb up Stabilization Status of unit	40 000 ft@-55°C 30 min. 1 000 ft/min to 70 000 ft@-55°C, 30 min. unit operating	MIL-STD-810E Method 500.3
Humidity cyclic	Number of cycle Cycle duration Relative humidity variation Temperature variation Status of unit	10 Cycle I : 24 Hrs 60 % to 88 % 31°C to 41°C unit not operating	MIL-STD-810E Method 507.3
Humidity steady	Damp heat Temperature Duration Status of unit	93 % relative humidity 40°C 56 days unit not operating	MIL-STD-202G Method 103B
Salt atmosphere	Temperature Concentration NaCl Duration Status of unit	35°C 5 % 48 Hrs unit not operating	MIL-STD-810E Method 509.3
Temperature cycling	Number of cycles Temperature change Transfert time Steady state time Status of unit	200 -40°C / +85°C 40 min. 20 min. unit operating	MIL-STD-202A Method 102A
Temperature shock	Number of shocks Temperature change Transfert time Steady state time Status of unit	100 -55°C / +105°C 10 sec. 20 min. unit not operating	MIL-STD-202G Method 107G
Mechanical Qualifications			
Vibration (Sinusoidal)	Number of cycles Frequency / amplitude Frequency / acceleration Duration Status of unit	10 cycles in each axis 10 to 60 Hz / 0.7 mm 60 to 2 000 Hz / 10 g 2h 30 min. per axis unit not operating	MIL-STD-810D Method 514.3
Shock (Half sinus)	Number of shocks Peak acceleration Duration Shock form Status of unit	3 shocks in each axis 100 g 6 ms 1/2 sinusoidal unit not operating	MIL-STD-810D Method 516.3
Bump (Half sinus)	Number of bumps Peak acceleration Duration Status of unit	2 000 bumps in each axis 40 g 6 ms unit not operating	MIL-STD-810D Method 516.3

8- Dimensions

Dimension are given in mm (inches). Tolerance : +/- 0,2 mm (+/-0.01") unless otherwise indicated.
Weight : 25 grams (0.882 Ozs) max.

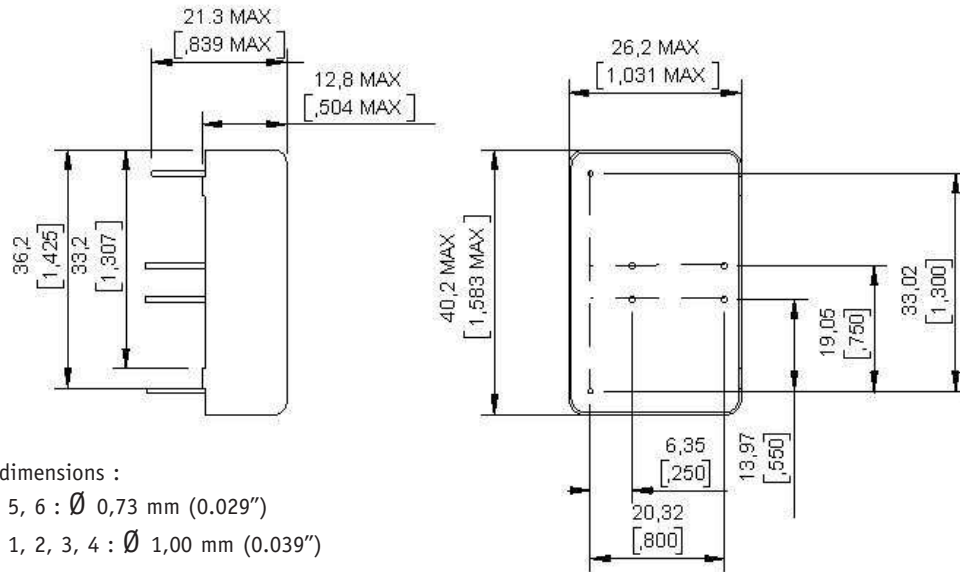

9- Materials

Case : Metallic case black anodized coating.

Pins : Plated with pure matte tin over nickel underplate.

10- Product Marking

Upper face : Company logo, location of manufacturing.

Side face : Module reference, option, date code : year and week of manufacturing.

11- Connections

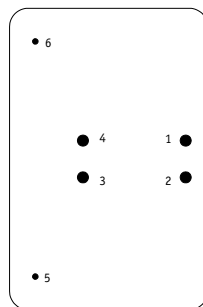

Bottom view

Pin	Single
1	+ Input (Vi)
2	- Input (Gi)
3	- Output (Go)
4	+ Output (Vo)
5	Ground (Gnd)
6	Ground (Gnd)



For more detailed specifications and applications information, contact :

International Headquarters	North American Headquarters
Marketing and Sales department	GAIA Converter Canada, Inc
GAIA Converter - France	Address : 6611 Thimens
Address : B.P. 26 - 33186 LE HAILLAN - FRANCE	ST-LAURENT, QUEBEC - CANADA H4S 1W2
Tel. : + (33)-5-57-92-12-80	Tel. : (514)-333-3169
Fax : + (33)-5-57-92-12-89	Fax : (514)-333-4519

Represented by :

Information given in this datasheet is believed to be accurate and reliable. However, no responsibility is assumed for the consequence of its use nor for any infringement of patents or other rights of third parties which may result from its use. These products are sold only according to GAIA Converter general conditions of sale, unless otherwise confirmed by writing. Specifications subject to change without notice.